

TC44 TC65 TC85 TCA45



BID SPECIFICATIONS

STANDARD

- * ALL TEMPERED, DOUBLE PANE GLASS FRONT AND SIDES
- * GALVANIZED STEEL CHASSIS CONSTRUCTION
- * INSULATED WITH DENSE NON-CFC ECOLOGIC POLYURETHANE FOAM
- * INSIDE STRUCTURE MADE OF HIGH GLOSS 304 STAINLESS STEEL
- * STAINLESS STEEL WORK SURFACE
- * DIGITAL DIAGNOSTIC CONTROL SYSTEM WITH PROGRAMMABLE DEFROSTING
- * REAR PLEXIGLASS SLIDING DOORS
- * SELF-CONTAINED, AIR-COOLED CONDENSING UNIT
- * UNIQUE FAN ASSISTED AIRFLOW DESIGN

- * TILT BACK FRONT GLASS
- * DIGITAL HUMIDITY CONTROL
- * REFRIGERATED DECK / NON-REFRIGERATED SHELF
- * SILVER ANODIZED ALUMINUM TRIM
- * TIERED STAINLESS STEEL DECK
- * MULTIPLEXING CAPABILITY WITH GELATO, PASTRY, DELI, AND CHOCOLATE CASE APPLICATIONS
- * THE STANDARD LIMITED WARRANTY INCLUDES:
5 YEAR COMPRESSOR: 1 YEAR PARTS; 90 DAYS LABOR

OPTIONAL

- * LED LIGHTING
- * CASTERS
- * GRANITE WORK SURFACE (OPERATOR SIDE)
- * REMOTE CONDENSING UNIT

- * FACTORY STANDARD MATTE WHITE FRONT AND SIDE PANELS

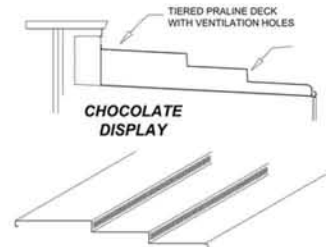

TECNICA (FORMERLY VENTURA XP II) Chocolate Case Technical Specifications

Same as Deli Refrigerated Case. but includes drawer

Model no.	Factory Codes	Case Height	* Case Lengths	Case Depth	Crated Weights (lb)	Line Voltage	Breaker Size	Amp Draw	Working Temp F	Comp. HP	Shelf
TC44	RP 2M	53.35"	44.10"	47.75"	590	220/1/60	20amps	12	38	1/2 HP	1
TC65	RP 3M	53.35"	64.75"	47.75"	745	220/1/60	20amps	12	38	1/2 HP	1
TC85	RP 4M	53.35"	85.43"	47.75"	950	220/1/60	20amps	12	38	3/4 HP	1
TCA45	RVC A45	53.35"	* A & B *	47.75"	565	220/1/60	20amps	12	38	1/2 HP	1

* Case length with standard end panels

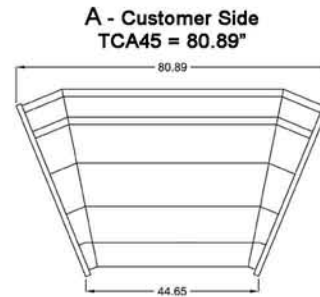
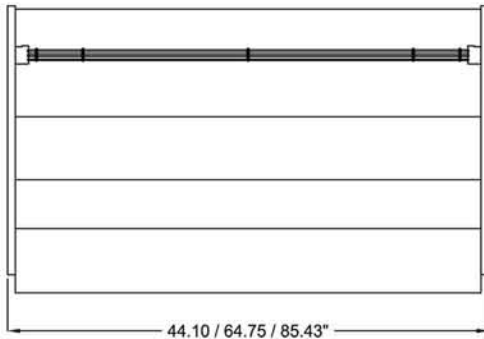
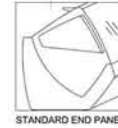

B - Server Side
TCA45 = 44.65"

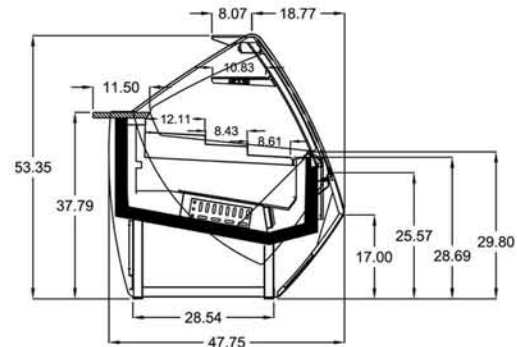
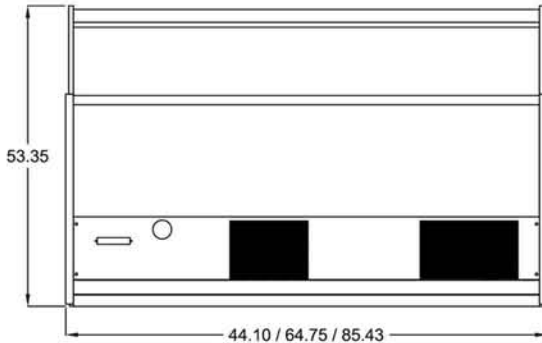

PLAN & REAR VIEW

A45 PLAN VIEW & SIDE VIEW

LISTINGS:

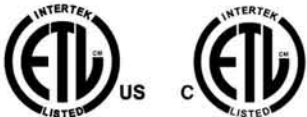

ELECTRICAL CONNECTION

Display cases are shipped with applicable junction box for hardwired installation
Options exist for several NEMA configurations
Plug and/or receptacle configurations are at the discretion of the electrical installer

NOTE:

Required ambient conditions: 75°F; 55% RH
Drawing and Specifications are subject to change without notice

CLABO USA INC.
2556 Barrington Court,
Hayward, CA 94545 USA
PH 800.672.2784
FAX 510.441.0401
<http://www.otl-america.com>