

G10

G16

G22



BID SPECIFICATIONS

- * LED LIGHTING
- * DOUBLE PANE HEATED GLASS FRONT AND SIDES
- * REAR PLEXIGLASS SLIDING DOORS
- * RESERVE PAN STORAGE
- * HYDRAULIC LIFT UP FRONT GLASS
- * BACK & INSIDE STRUCTURE MADE OF HIGH GLOSS 304 STAINLESS STEEL
- * DIGITAL DIAGNOSTIC CONTROL SYSTEM WITH PROGRAMMABLE DEFROSTING
- * GALVANIZED STEEL CHASSIS CONSTRUCTION
- * INSULATED WITH DENSE NON-CFC ECOLOGIC POLYURETHANE FOAM
- * STAINLESS STEEL WORK SURFACE
- * REMOVABLE STAINLESS STEEL DECK

- * SELF-CONTAINED AIR-COOLED CONDENSING UNIT
- * UNIQUE FAN ASSISTED AIRFLOW DESIGN
- * SILVER ANODIZED ALUMINUM FINISH
- * MULTIPLEXING CAPABILITY WITH GELATO, PASTRY, DELI, AND CHOCOLATE CASE APPLICATIONS
- * DISPLAY CASE(S) HAVE INTERGRATED ELECTRONIC TIME AND TEMPERATURE CONTROLLER(S) WITH HOT GAS DEFROST STANDARD ON GELATO MODELS
- * THE STANDARD LIMITED WARRANTY INCLUDES: 5 YEAR COMPRESSOR: 1 YEAR PARTS AND LABOR

Easy Delivery

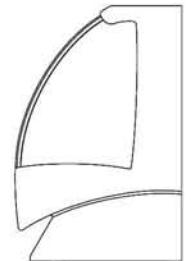

Only 35.25" Deep

STANDARD

- * CASTERS
- * REMOTE CONDENSING UNIT
- * ROLL DOWN CURTAIN
- * DECORATIVE END PANELS

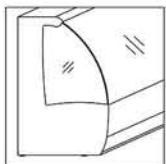

STANDARD END PANEL

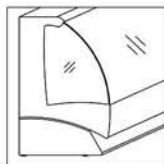

DECORATIVE END PANEL (OPTIONAL)

ADD 1.50" TO TOTAL LENGTH

- * STAINLESS STEEL TEMPLATE TO ACCOMMODATE 2.5 GALLON OR 3 GALLON ROUND ICE CREAM TUBS

- * PANS NOT INCLUDED



- * FACTORY STANDARD MATTE WHITE FRONT AND SIDE PANELS



OPTIONAL

Italiana Ice Cream / Gelato Case Technical Specifications

Models	Case Height	* Case Lengths	Depth	Crated Weights (lb)	Line Voltage	Breaker Sizes	Amp Draws	Working Temp F	Pan Capacity			Comp. HP
									4 Liter	5 Liter	Round Tubs	
G10	54.00"	40.75"	35.25"	860	220/1/60	20 amp	12	-10 to +10	10	7	5	3/4 HP
G16	54.00"	60.50"	35.25"	1017	220/1/60	30 amp	14	-10 to +10	16	11	8	1 HP
G22	54.00"	80.25"	35.25"	1140	220/1/60	30 amp	14	-10 to +10	22	16	10	1 1/2 HP

* Case lengths are specified with standard end panels

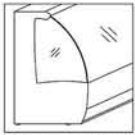

STANDARD END PANEL

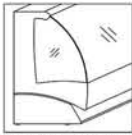

DECORATIVE END PANEL (OPTIONAL)
ADD 1.50" TO TOTAL LENGTH

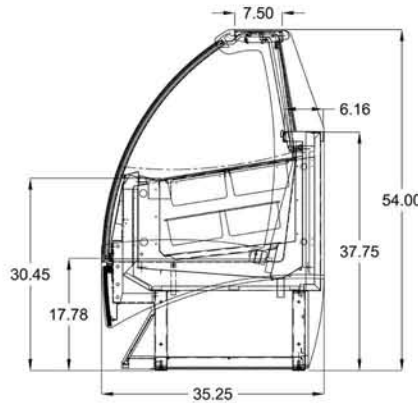
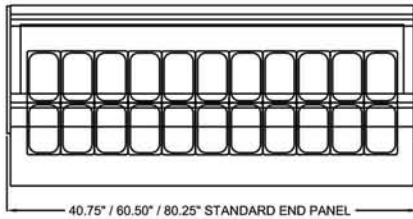

Models	Pan Layouts	Pan Sizes
100 / 2.5 G10		4 Liter
100 / 2.5 G10		5 Liter
150 / 2.8 G16		4 Liter
150 / 2.8 G16		5 Liter
200 / 2.11 G22		4 Liter
200 / 2.11 G22		5 Liter

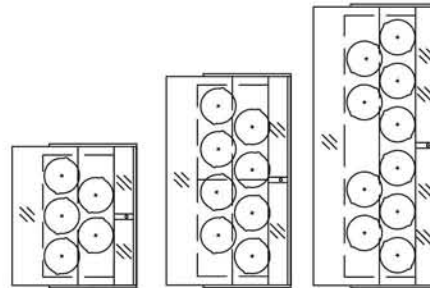
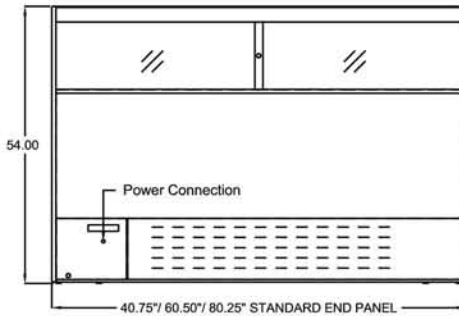

PLAN & REAR VIEW

SIDE VIEW & ROUND TUBS LAYOUTS

LISTINGS:



ELECTRICAL CONNECTION:

Display cases are shipped with applicable junction box for hardwired installation
Options exist for several NEMA configurations
Plug and/or receptacle configurations are at the discretion of the electrical installer

NOTE:

Required ambient conditions: 75°F; 55% RH
Drawing and Specifications are subject to change without notice

CLABO USA INC.
2556 Barrington Court,
Hayward, CA 94545 USA
PH 800.672.2784
FAX 510.441.0401
<http://www.otl-america.com>